

Student Manual

Pre-Lab Introduction to DNA Fingerprinting

You are about to perform a procedure known as DNA fingerprinting. The data obtained may allow you to determine if the samples of DNA that you will be provided with are from the same individual or from different individuals. For this experiment it is necessary to review the structure of DNA molecules.

DNA consists of a series of nitrogenous base molecules held together by weak hydrogen bonds. These base pairs are in turn bonded to a sugar-phosphate backbone. The four nitrogenous bases are **adenine**, **thymine**, **guanine**, and **cytosine** (**A**, **T**, **G**, and **C**). Remember the base-pairing rule is **A - T** and **G - C**. Refer to the figure below of a DNA molecule.

The Structure of DNA

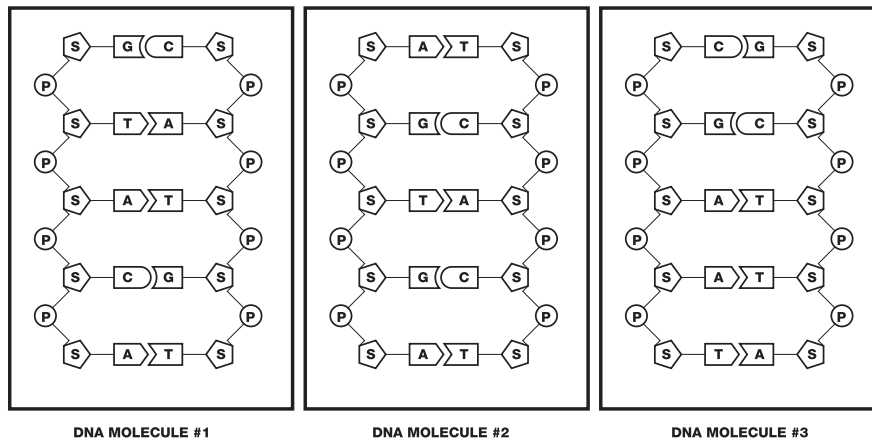

The schematics above represent a very small section of DNA from three different individuals. In this representation of DNA the symbol system is as follows:

Backbone:

S = Five carbon sugar molecule known as deoxyribose

P = Phosphate group

DNA Nucleotide Bases:

A = adenine **C** = cytosine **G** = guanine **T** = thymine

Analysis of the three DNA samples above (see next page) might help us detect similarities and differences in samples of DNA from different people.

Pre-Lab Focus Questions: Introduction to DNA Fingerprinting

Consideration What is the structure of DNA?

1. Compare the “backbone” of the sugar-phosphate arrangement in the side chains of all three figures. Are there any differences?
2. In the above figure, do all three samples contain the same bases? Describe your observations.
3. Are the bases paired in an identical manner in all three samples? Describe the pattern of the base pair bonding.
4. In your attempt to analyze DNA samples from three different individuals, what conclusions can you make about the similarities and differences of the DNA samples?
5. What will you need to compare between these DNA samples to determine if they are identical or non-identical?

Lesson 1 Restriction Digestion of DNA Samples

Consideration How can we detect differences in base sequences?

At first sight, your task might seem rather difficult. You need to determine if the *linear* base pair **sequence** in the DNA samples is identical or not! An understanding of some historically important discoveries in **recombinant DNA technology** might help you to develop a plan.

In 1968, Dr. Werner Arber at the University of Basel, Switzerland and Dr. Hamilton Smith at the Johns Hopkins University, Baltimore, discovered a group of enzymes in bacteria, which when added to **any** DNA will result in the breakage [**hydrolysis**] of the sugar-phosphate bond between certain specific nucleotide bases [**recognition sites**]. This causes the double strand of DNA to break along the recognition site and the DNA molecule becomes fractured into two pieces. These molecular scissors or “cutting” enzymes are **restriction endonucleases**.

Two common restriction enzymes (endonucleases) are *EcoRI* and *PstI* which will be provided to you in this lab procedure. To better understand how *EcoRI* and *PstI* may help you in performing your DNA fingerprinting experiment, first you must understand and visualize the nature of the “cutting” effect of a restriction endonuclease on DNA:

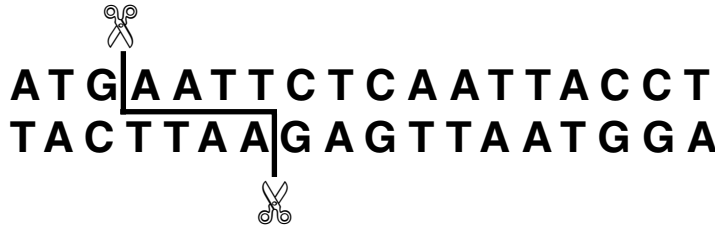

The line through the base pairs represents the sites where bonds will break if the restriction endonuclease *EcoRI* recognizes the site **GAATTC**. The following analysis questions refer to how a piece of DNA would be affected if a restriction endonuclease were to “cut” the DNA molecule in the manner shown above.

1. How many **pieces** of DNA would result from this cut? _____
2. Write the **base sequence** of the DNA fragments on both the left and right side of the “cut”.

Left:

Right:

3. What differences are there in the two pieces?

4. DNA fragment size can be expressed as the number of base pairs in the fragment. Indicate the size of the fragments [mention any discrepancy you may detect].
- The smaller fragment is _____ base pairs (bp).
 - What is the length of the longer fragment? _____
5. Consider the two samples of DNA shown below - single strands are shown for simplicity:

Sample #1

CAGTGATCTCGAATTCGCTAGTAACGTT

Sample #2

TCATGAATTCCTGGAATCAGCAAATGCA

If both samples are treated with the restriction enzyme *EcoRI* [recognition sequence **GAATTC**] then indicate the number of fragments and the size of each fragment from each sample of DNA.

Sample # 1

Sample # 2

of fragments: _____

of fragments: _____

List fragment size in order: largest —> smallest

Sample # 1

Sample # 2

Lesson 1 Restriction Digestion of DNA Samples

Upon careful observation, it is apparent that the only difference between the DNA of different individuals is the linear sequence of their base pairs. In the lab, your team will be given 6 DNA samples. Recall that your task is to determine if any of them came from the same individual or if they came from different individuals.

Thus far you have learned the following:

- The similarities and differences between the DNA from different individuals.
- How restriction endonucleases cut (hydrolyze) DNA molecules.
- How adding the same restriction endonuclease to two samples of DNA might provide some clues about differences in their linear base pair sequence.

Now that you have a fairly clear understanding of these three items you are ready to proceed to the first phase of the DNA fingerprinting procedure—performing a restriction digest of your DNA samples.

Your Workstation Checklist

Make sure the materials listed below are present at your lab station prior to beginning the lab.

Material Needed for Each Workstation	Quantity	(✓)
Agarose gel electrophoresis system (electrophoresis chamber, casting tray, 8-well comb)	1	<input type="checkbox"/>
<i>EcoRI/PstI</i> enzyme mix	1 tube (80 µl)	<input type="checkbox"/>
Pipet tips, 2–200 µl	15 tips	<input type="checkbox"/>
Micropipet, 2–20 µl	1	<input type="checkbox"/>
Colored micro test tubes:		
green, blue, orange, violet, red, yellow	1	<input type="checkbox"/>
Permanent marker	1	<input type="checkbox"/>
Waste container	1	<input type="checkbox"/>
Foam micro test tube holder	1	<input type="checkbox"/>
Laboratory tape (not 3M Scotch brand or similar tape)	1	<input type="checkbox"/>
Instructor's Workstation		
Crime scene DNA with buffer, rehydrated	1 vial	<input type="checkbox"/>
Suspect 1 DNA with buffer, rehydrated	1 vial	<input type="checkbox"/>
Suspect 2 DNA with buffer, rehydrated	1 vial	<input type="checkbox"/>
Suspect 3 DNA with buffer, rehydrated	1 vial	<input type="checkbox"/>
Suspect 4 DNA with buffer, rehydrated	1 vial	<input type="checkbox"/>
Suspect 5 DNA with buffer, rehydrated	1 vial	<input type="checkbox"/>
Molten 1% agarose in 1x TAE (See Advance Prep)	40–50 ml per gel	<input type="checkbox"/>
37°C water bath or incubator (optional)	1 per class	<input type="checkbox"/>
Microcentrifuge	1 per class	<input type="checkbox"/>
or mini centrifuge	4 per class	<input type="checkbox"/>

Observations

- 1) Describe the samples of DNA (physical properties).
- 2) Is there any observable difference between the samples of DNA?
- 3) Describe the appearance of the restriction endonuclease mix.
- 4) Combine and react.

Using a new pipet tip for each sample, pipet 10 μ l of the enzyme mix “ENZ” to each reaction tube as shown below. Pipet up and down carefully to mix well.

Note: Change tips whenever you switch reagents, or, if the tip touches any of the liquid in one of the tubes accidentally. When in doubt, change the tip! DNA goes in the tube before the enzyme. Always add the enzyme last.

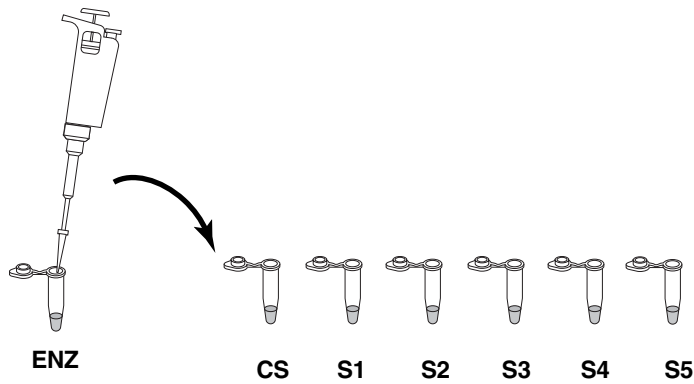

Now your DNA samples should contain:

DNA Samples (10 μ l each)	<i>EcoRI/PstI</i> Enzyme Mix	Total Reaction Volume
Crime Scene [CS]	10 μ l	20 μ l
Suspect 1 [S1]	10 μ l	20 μ l
Suspect 2 [S2]	10 μ l	20 μ l
Suspect 3 [S3]	10 μ l	20 μ l
Suspect 4 [S4]	10 μ l	20 μ l
Suspect 5 [S5]	10 μ l	20 μ l

5. Mix the tube contents.

Tightly cap on each tube. Mix the components by gently flicking the tubes with your finger. If there is a centrifuge available, pulse the tubes for two seconds to force the liquid into the bottom of the tube to mix and combine reactants. (Be sure the tubes are in a **BALANCED** arrangement in the rotor). If your lab is not equipped with a centrifuge, briskly shake the tube (once is sufficient) like a thermometer. Tapping the tubes on the lab bench will also help to combine and mix the contents.

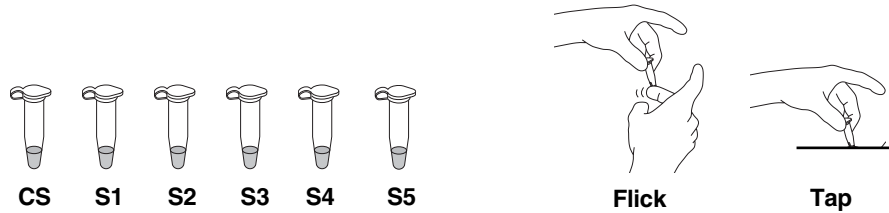

6. Incubate the samples.

Place the tubes in the foam micro tube holder and incubate them at 37°C for 45 minutes. Alternatively, the tubes can be incubated in a large volume of water heated to 37°C and allowed to slowly reach room temperature overnight. After the incubation, store the DNA digests in the refrigerator until the next lab period, or proceed directly to step 2 of Lesson 2 if instructed by your teacher.

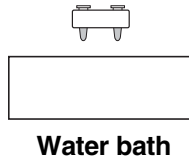

Note: While you are waiting, this is a good time to cast your agarose gel, unless they have already been prepared for you. Check with your teacher for the proper procedure.

Lesson 1 Restriction Digestion of DNA Samples

Review Questions

1. Before you incubated your samples, describe any visible signs of change in the contents of the tubes containing the DNA after it was combined with the restriction enzymes.
2. Can you see any evidence to indicate that your samples of DNA were fragmented or altered in any way by the addition of *EcoRI/PstI*? Explain.
3. In the absence of any visible evidence of change, is it still possible that the DNA samples were fragmented? Explain your reasoning.
4. (Answer the next day—after the restriction digest)
After a 24 hour incubation period, are there any visible clues that the restriction enzymes may have in some way changed the DNA in any of the tubes? Explain your reasoning.

Lesson 2 Agarose Gel Electrophoresis (Laboratory Procedure)

Student Workstations	Quantity	(✓)
Agarose gel electrophoresis system	1	<input type="checkbox"/>
Agarose gel	1	<input type="checkbox"/>
Digested DNA samples	6	<input type="checkbox"/>
<i>Hind</i> III lambda digest (DNA markers)	1	<input type="checkbox"/>
DNA sample loading dye	1	<input type="checkbox"/>
Permanent marker	1	<input type="checkbox"/>
Pipet tips, 2–20 μ l	13	<input type="checkbox"/>
Micropipet, 2–20 μ l	1	<input type="checkbox"/>
Waste container	1	<input type="checkbox"/>
Gel support film (if applicable)*	1	<input type="checkbox"/>
Fast Blast DNA stain, 1x or 100x*	120 ml per 2 stations	<input type="checkbox"/>
Large containers for destaining (if applicable)*	1–3 per 2 stations	<input type="checkbox"/>
Foam micro test tube holder	1	<input type="checkbox"/>
Power supply	1	<input type="checkbox"/>
Gel staining tray	1 per 2 stations	<input type="checkbox"/>
Electrophoresis buffer (1x TAE)**	275 ml per station	<input type="checkbox"/>
Instructor's Workstation		
Microcentrifuge	1	<input type="checkbox"/>
or mini centrifuge (optional)	4	<input type="checkbox"/>
Rocking platform (optional)	1	<input type="checkbox"/>

*If performing the quick staining procedure.

** 0.25 x TAE buffer is used for fast gel electrophoresis. Refer to Appendix D for detailed information.

Lesson 2 Agarose Gel Electrophoresis (Laboratory Procedure)

1. Obtain a preprepared agarose gel from your teacher, or if your teacher instructs you to do so, prepare your own gel.
2. After preparing the gel, remove your digested samples from the refrigerator.

Using a new tip for each sample add 5 μl of sample loading dye "LD" to each tube:

DNA Samples	Loading dye
Crime Scene [CS]	5 μl
Suspect 1 [S1]	5 μl
Suspect 2 [S2]	5 μl
Suspect 3 [S3]	5 μl
Suspect 4 [S4]	5 μl
Suspect 5 [S5]	5 μl

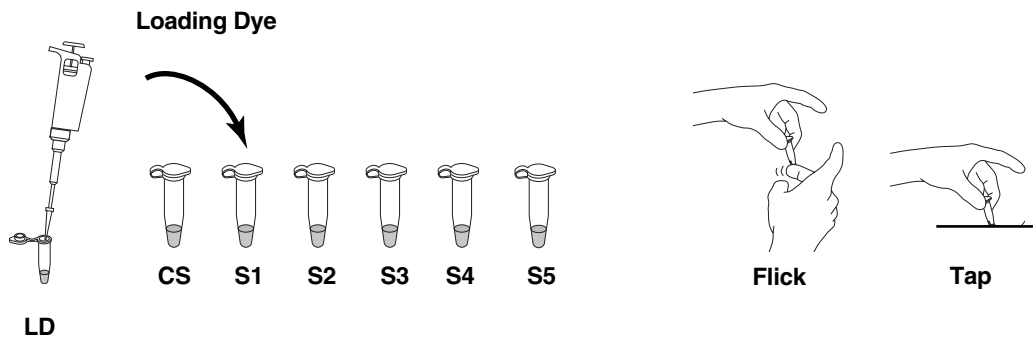

Tightly cap each tube. Mix the components by gently flicking the tubes with your finger. If a centrifuge is available, pulse spin the tubes to bring the contents to the bottom of the tube. Otherwise, gently tap the tubes on the table top.

3. Place the casting tray with the solidified gel in it, into the platform in the gel box. The wells should be at the (-) cathode end of the box, where the black lead is connected. Very carefully, remove the comb from the gel by pulling it straight up.
4. Pour ~ 275 ml of electrophoresis buffer into the electrophoresis chamber. Pour buffer in the gel box until it **just covers** the wells of the gel by 1–2 mm.

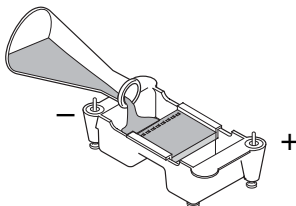

5. Obtain the tube of *Hind*III lambda digest (DNA marker). The loading dye should already have been added by your instructor.

- Using a separate pipet tip for each sample, load your digested DNA samples into the gel. Gels are read from left to right. The first sample is loaded in the well at the left hand corner of the gel.

- Lane 1: *Hind*III DNA size marker, clear tube, 10 μ l
- Lane 2: CS, green tube, 20 μ l
- Lane 3: S1, blue tube, 20 μ l
- Lane 4: S2, orange tube, 20 μ l
- Lane 5: S3, violet tube, 20 μ l
- Lane 6: S4, red tube, 20 μ l
- Lane 7: S5, yellow tube, 20 μ l

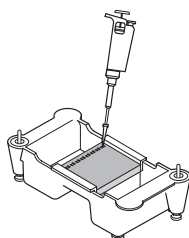

- Secure the lid on the gel box. The lid will attach to the base in only one orientation: red to red and black to black. Connect electrical leads to the power supply.
- Turn on the power supply. Set it for 100 V and electrophorese the samples for at least 30 min. The gel can be run for up to 40 min to improve resolution if the time is available. The Fast Gel Protocol in Appendix D allows the gel to be run in 20 min at 200 V.

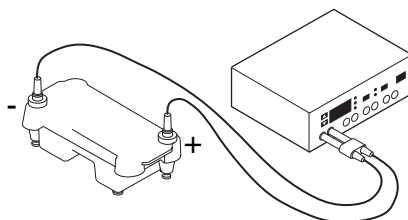

While you are waiting for the gel to run, you may begin the review questions on the following page.

- When the electrophoresis is complete, turn off the power supply and remove the lid from the gel box. Carefully remove the gel tray and the gel from the electrophoresis chamber. Be careful, the gel is very slippery! Proceed to pg 35 for detailed instructions on staining your gel.

Lesson 2 Agarose Gel Electrophoresis

Review Questions

1. The electrophoresis apparatus creates an electrical field with positive and negative poles at the ends of the gel. DNA molecules are negatively charged. To which electrode pole of the electrophoresis field would you expect DNA to migrate? (+ or -)? Explain.
2. What color represents the negative pole?
3. After DNA samples are loaded into the sample wells, they are “forced” to move through the gel matrix. What size fragments (large vs. small) would you expect to move toward the opposite end of the gel most quickly? Explain.
4. Which fragments (large vs. small) are expected to travel the shortest distance from the well? Explain.

Staining DNA with Fast Blast DNA Stain (Laboratory Procedure)

Consideration Are any of the DNA samples from the suspects the same as that of the individual at the crime scene?

Take a moment to think about how you will perform the analysis of your gel. In the final two steps, you will:

- Visualize DNA fragments in your gel.
- Analyze the number and positions of visible DNA bands on your gel.

Making DNA Fragments Visible

Since DNA is naturally colorless, it is not immediately visible in the gel. Unaided visual examination of the gel after electrophoresis indicates only the positions of the loading dyes and not the positions of the DNA fragments. DNA fragments are visualized by staining the gel with a blue stain called Fast Blast DNA stain. The blue stain molecules are positively charged and have a high affinity for the DNA. These blue stain molecules strongly bind to the DNA fragments and allow DNA to become visible. These visible bands of DNA may then be traced, photographed, sketched, or retained as a permanently dried gel for analysis. Detailed instruction on staining your gel are found on the following pages.

The drawing below represents an example of a stained DNA gel after electrophoresis. For fingerprinting analysis, the following information is important to remember:

- Each lane has a different sample of DNA
- Each DNA sample was treated with the same restriction endonucleases.

With reference to the numbered lanes, analyze the bands in the gel drawing below, then answer the questions on page 40. Note that this picture is an example and it may not correspond to the pattern of bands that you will see in the lab.

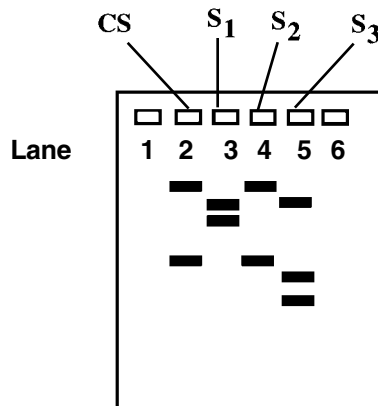

Staining DNA with Fast Blast DNA Stain (Laboratory Procedure)

There are two protocols for using Fast Blast DNA stain in the classroom. Use option 1 for quick staining of gels to visualize DNA bands in 12–15 minutes, and option 2 for overnight staining. Depending on the amount of time available, your teacher will decide which protocol to use. Two student teams will stain the gels per staining tray (you may want to notch gel corners for identification). Mark staining trays with initials and class period before beginning this activity.

WARNING

Although Fast Blast DNA stain is nontoxic and noncarcinogenic, latex or vinyl gloves should be worn while handling the stain or stained gels to keep hands from becoming stained blue. Lab coats or other protective clothing should be worn to avoid staining clothes.

Protocol 1: Quick Staining of Agarose Gels in 100x Fast Blast DNA Stain

This protocol allows quick visualization of DNA bands in agarose gels within 15 minutes. For quick staining, Fast Blast DNA stain (500x) should be diluted to a **100x** concentration. We recommend using 120 ml of 100x Fast Blast to stain two 7 x 7 cm or 7 x 10 cm agarose gels in individual staining trays provided in Bio-Rad's education kits. If alternative staining trays are used, add a sufficient volume of staining solution to completely submerge the gels.

Following electrophoresis, agarose gels must be removed from their gel trays before being placed in the staining solution. This is easily accomplished by holding the base of the gel tray in one hand and gently pushing out the gel with the thumb of the other hand. Because the gel is fragile, special attention must be given when handling it. We highly recommend using a large spatula or other supportive surface to transfer the gel from one container to another. Destaining requires the use of at least one large-volume container, capable of holding at least 500 ml, at each student workstation. Each student team may utilize separate washing containers for each wash step, or simply use a single container that is emptied after each wash and refilled for the next wash.

1. Label the staining trays with your initials and class period. You will stain 2 gels per tray.

2. Stain gels

Remove each gel from the gel tray and carefully slide it into the staining tray. Pour approximately 120 ml of 100x stain into the staining tray. If necessary, add more 100x stain to completely submerge the gels. Stain the gels for 2–3 minutes, but not for more than 3 minutes. Using a funnel, pour the 100x stain into a storage bottle and save it for future use. **The stain can be reused at least 7 times.**

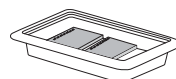
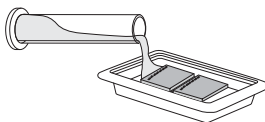
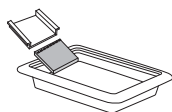

2–3 minutes

3. Rinse gels

Transfer the gels into a large container containing 500–700 ml of clean, warm (40–55°C) tap water. Gently shake the gel in the water for ~10 seconds to rinse.

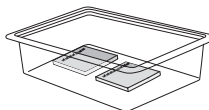

10 seconds

4. Wash gels

Transfer the gel into a large container with 500–700 ml of clean, warm tap water. Gently rock or shake the gel on a rocking platform for 5 minutes. If no rocking platform is available, move the gels gently in the water once every minute.

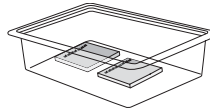

5 minutes

5. Wash gels

Perform a second wash as in step 4.

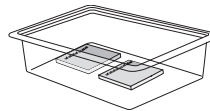

5 minutes

6. Record results

Pour off the water and examine the stained gels for expected DNA bands. The bands may appear fuzzy immediately after the second wash, but will begin to develop into sharper bands within 5–15 minutes after the second wash. This is due to Fast Blast stain molecules migrating into the gel and binding more tightly to the DNA.

To obtain maximum contrast, additional washes in warm water may be necessary. Destain to the desired level, but do not wash the gel in water overnight. If you cannot complete the destaining in the allocated time, you may transfer the gel to 1x Fast Blast stain for overnight staining. **See Protocol 2.**

- a. Place your gel on a light background and record your results by making a diagram as follows. Place a clear sheet of plastic sheet or acetate over the gel. With a permanent marker, trace the wells and band patterns onto the plastic sheet to make a replica picture of your gel. Remove the plastic sheet for later analysis. Alternatively, gels can be photocopied on a yellow piece of transparent film for optimal contrast.
- b. Dry the agarose gel as a permanent record of the experiment.
 - i. Trim away any unloaded lanes with a knife or razor blade. Cut your gel from top to bottom to remove the lanes that you did not load samples into, leaving only lanes 1–4.
 - ii. Place the gel directly upon the hydrophilic side of a piece of gel support film. (Water will form beads on the hydrophobic side of a piece of gel support film.) Center the gel on the film and remove bubbles that may form between the gel and film. Place the film on a paper towel and let the gel dry in a well-ventilated area, making sure to avoid direct exposure to light. As the gel dries it will bond to the film but will not shrink. If left undisturbed on the support film, the gel will dry completely at room temperature after 2–3 days. The result will be a flat, transparent, and durable record for the experiment.

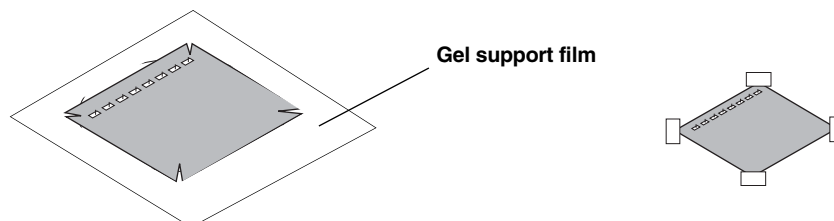

Protocol 2: Overnight Staining of Agarose Gels in 1x Fast Blast DNA Stain

For overnight staining, Fast Blast DNA stain (500x) should be diluted to a **1x** concentration. We recommend using 120 ml of 1x Fast Blast to stain two 7 x 7 cm or 7 x 10 cm agarose gels in individual staining trays provided in Bio-Rad's education kits. If alternative staining trays are used, add a sufficient volume of staining solution to completely submerge the gels.

Following DNA electrophoresis, agarose gels must be removed from their gel trays before being placed in the staining solution. This is easily accomplished by holding the base of the gel tray in one hand and gently pushing out the gel with the thumb of the other hand. Because the gel is fragile, special attention must be given when handling it.

1. Label the staining tray with your initials and class period. You will stain 2 gels per tray.

2. Stain gels (overnight)*

Pour **1x** stain into a gel staining tray. Remove the gel from the gel tray and carefully slide it into the staining tray containing the stain. If necessary, add more 1x staining solution to completely submerge the gels. Place the staining tray on a rocking platform and agitate overnight. If no rocking platform is available, agitate the gels staining tray a few times during the staining period. You should begin to see DNA bands after 2 hours, but at least 8 hours of staining is recommended for complete visibility of stained bands.

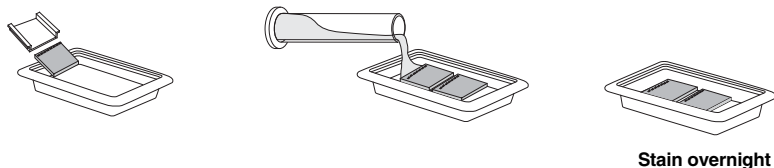

* It is crucial that you shake gels gently and intermittently while performing the overnight staining in 1x Fast Blast stain since smaller fragments tend to diffuse without shaking.

3. Record results

No destaining is required after staining with 1x Fast Blast. The gels can be analyzed immediately after staining.

- a. Place your gel on a light background and record your results by making a diagram as follows. Place a clear sheet of plastic sheet or acetate over the gel. With a permanent marker, trace the wells and band patterns onto the plastic sheet to make a replica picture of your gel. Remove the plastic sheet for later analysis. Alternatively, gels can be photocopied on a yellow piece of transparent film for optimal contrast.
- b. Dry the agarose gel as a permanent record of the experiment.
 - i. Trim away any unloaded lanes with a knife or razor blade. Cut your gel from top to bottom to remove the lanes that you did not load samples into, leaving only lanes 1–4.
 - ii. Place the gel directly upon the hydrophilic side of a piece of gel support film. (Water will form beads on the hydrophobic side of a piece of gel support film.) Center the gel on the film on a paper towel and let the gel dry in a well-ventilated area, making sure to avoid direct exposure to light. As the gel dries it will bond to the film but will not shrink. If left undisturbed on the support film, the gel will dry completely at room temperature after 2–3 days. The result will be a flat, transparent, and durable record for the experiment.

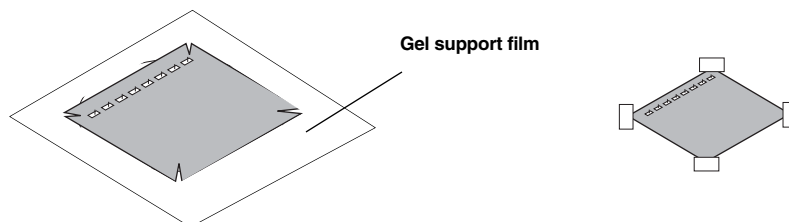

Note: Avoid extended exposure of dried gels to direct light to prevent band fading. However, DNA bands will reappear if the dried gels are stored in the dark for 2–3 weeks after fading.

Post-Lab: Thought Questions

1. What can you assume is contained within each band?
2. If this were a fingerprinting gel, how many samples of DNA can you assume were placed in each separate well?
3. What would be a logical explanation as to why there is more than one band of DNA for each of the samples?
4. What caused the DNA to become fragmented?
5. Which of the DNA samples have the same number of restriction sites for the restriction endonucleases used? Write the lane numbers.
6. Which sample has the smallest DNA fragment?
7. Assuming a circular piece of DNA (plasmid) was used as starting material, how many restriction sites were there in lane three?
8. From the gel drawing on page 35, which DNA samples appear to have been “cut” into the same number and size of fragments?
9. Based on your analysis of the example gel drawing on page 35, what is your conclusion about the DNA samples in the drawing? Do any of the samples seem to be from the same source? If so, which ones? Describe the evidence that supports your conclusion.